

What does a particle physicist do ?

- The building of detectors

Examples:

- The TPC (Time Projection Chamber)
- The STIC (Electromagnetic calorimeter)

- Analysis of the data from the experiment

Examples at LEP 1:

- Luminosity
- Studies of the Z-boson

Examples at LEP 2:

- Studies of the W-boson
- Search for new particles

The Time Projection Chamber

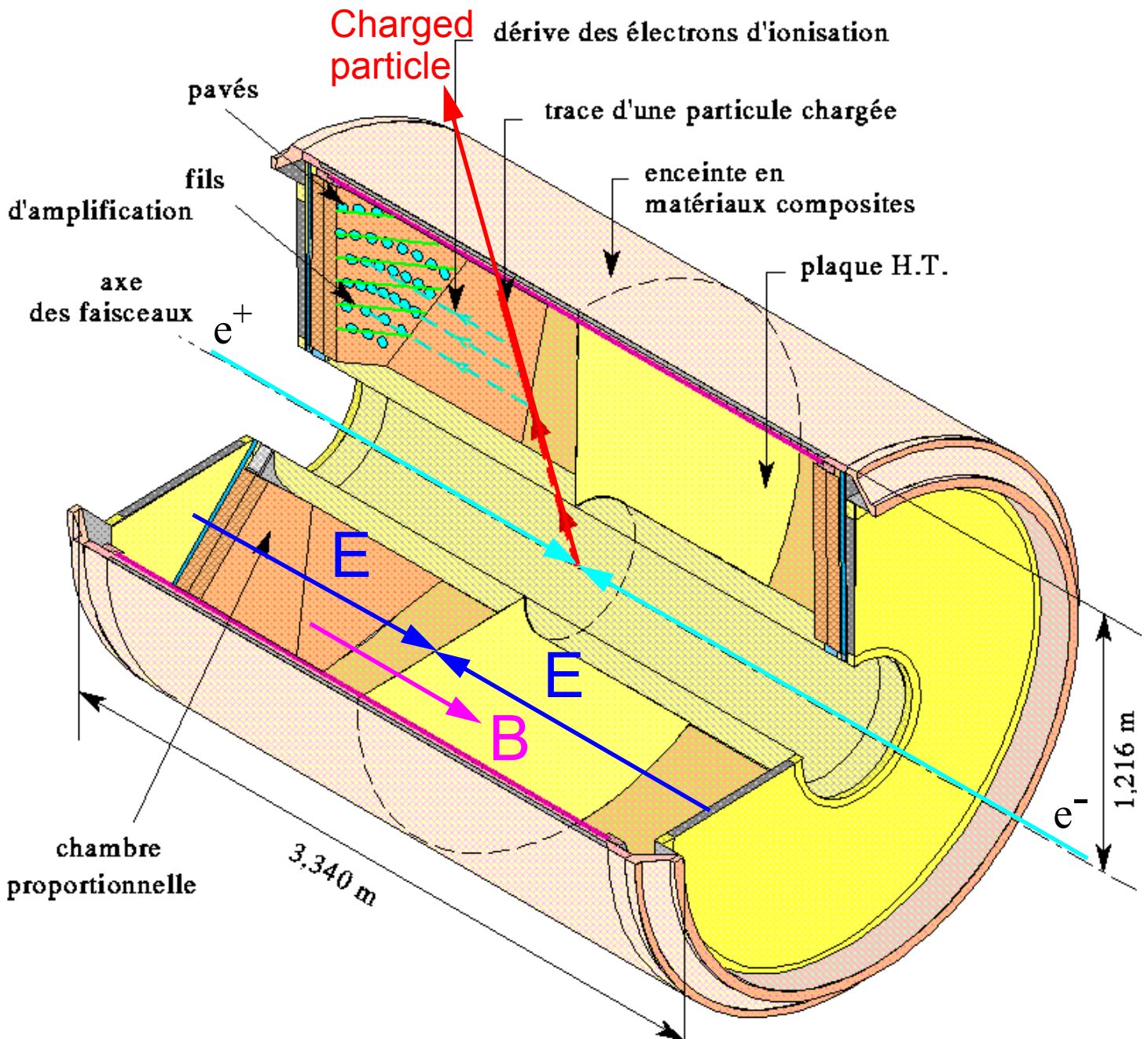

A charged particle ionize the gas in the cylinder and the electrons drift in an electrical field to the detectors at the ends of the cylinder.

Three-dimensional tracks can be reconstructed from the signals from the detectors.

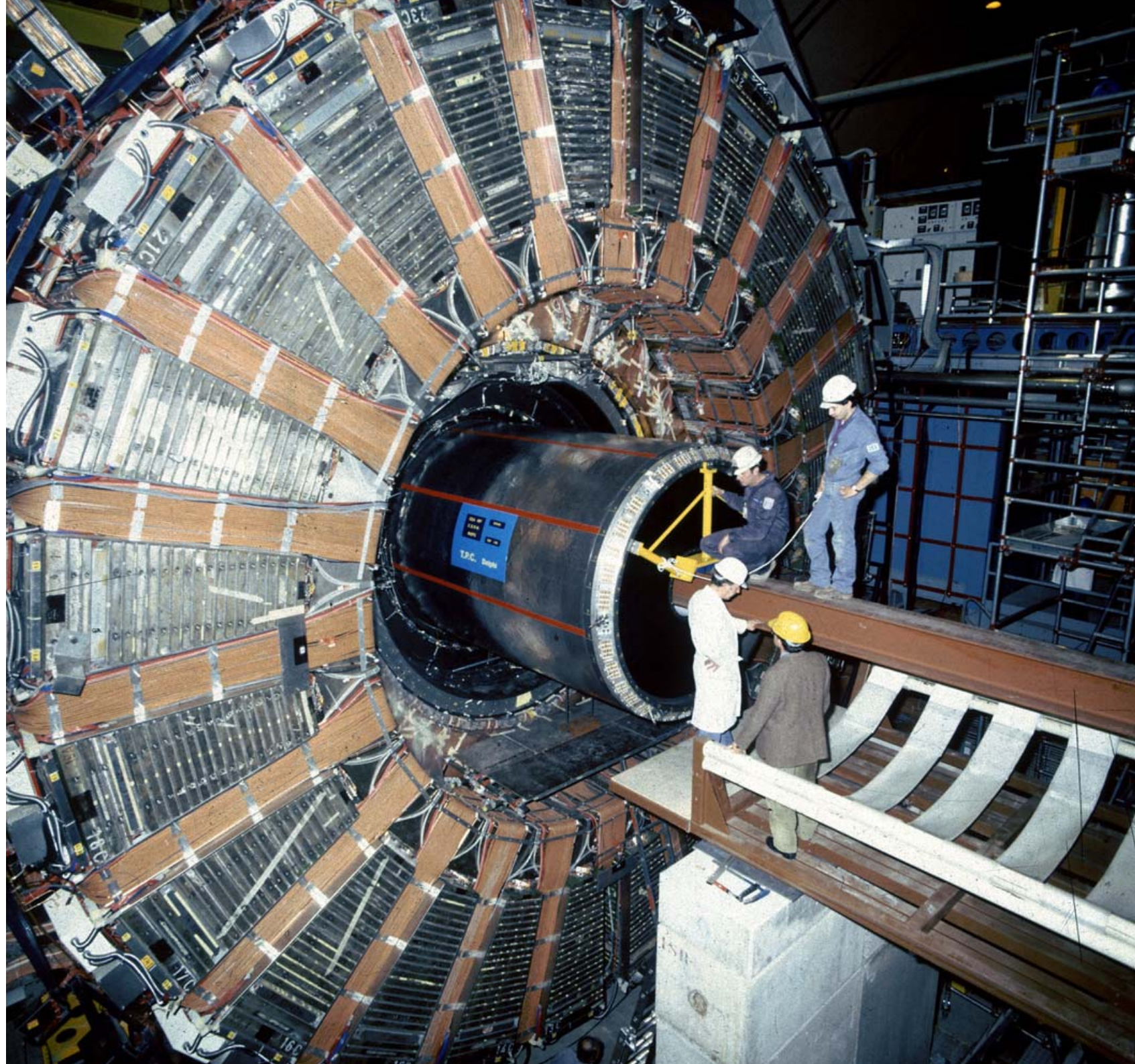

The calorimetric processes

An electromagnetic shower

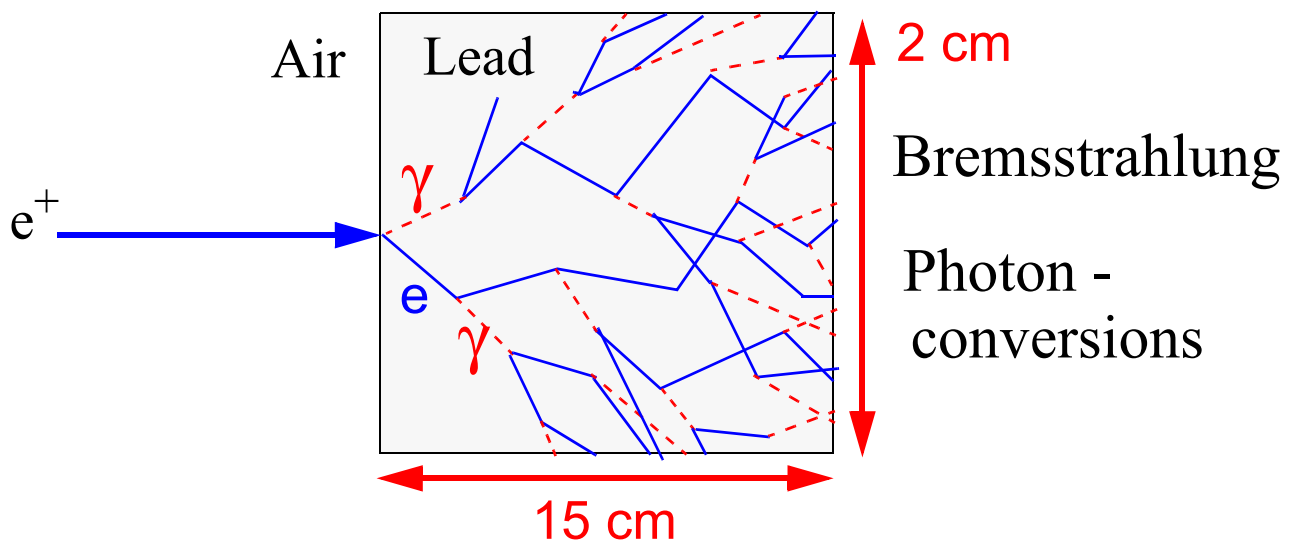

A hadronic shower

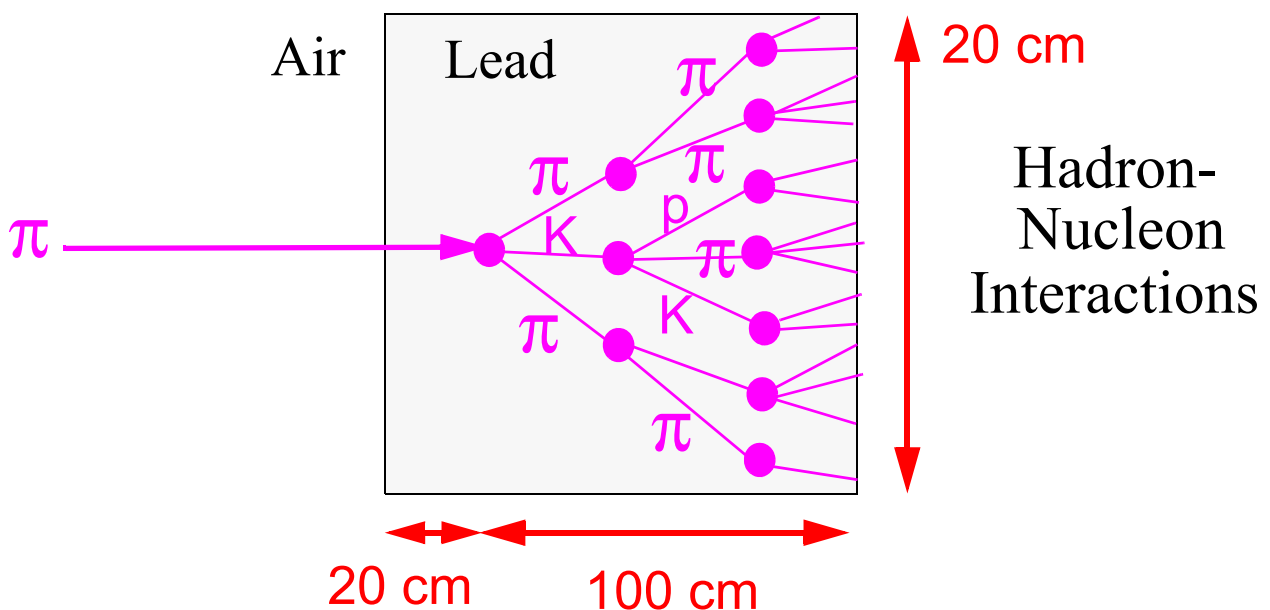

STIC

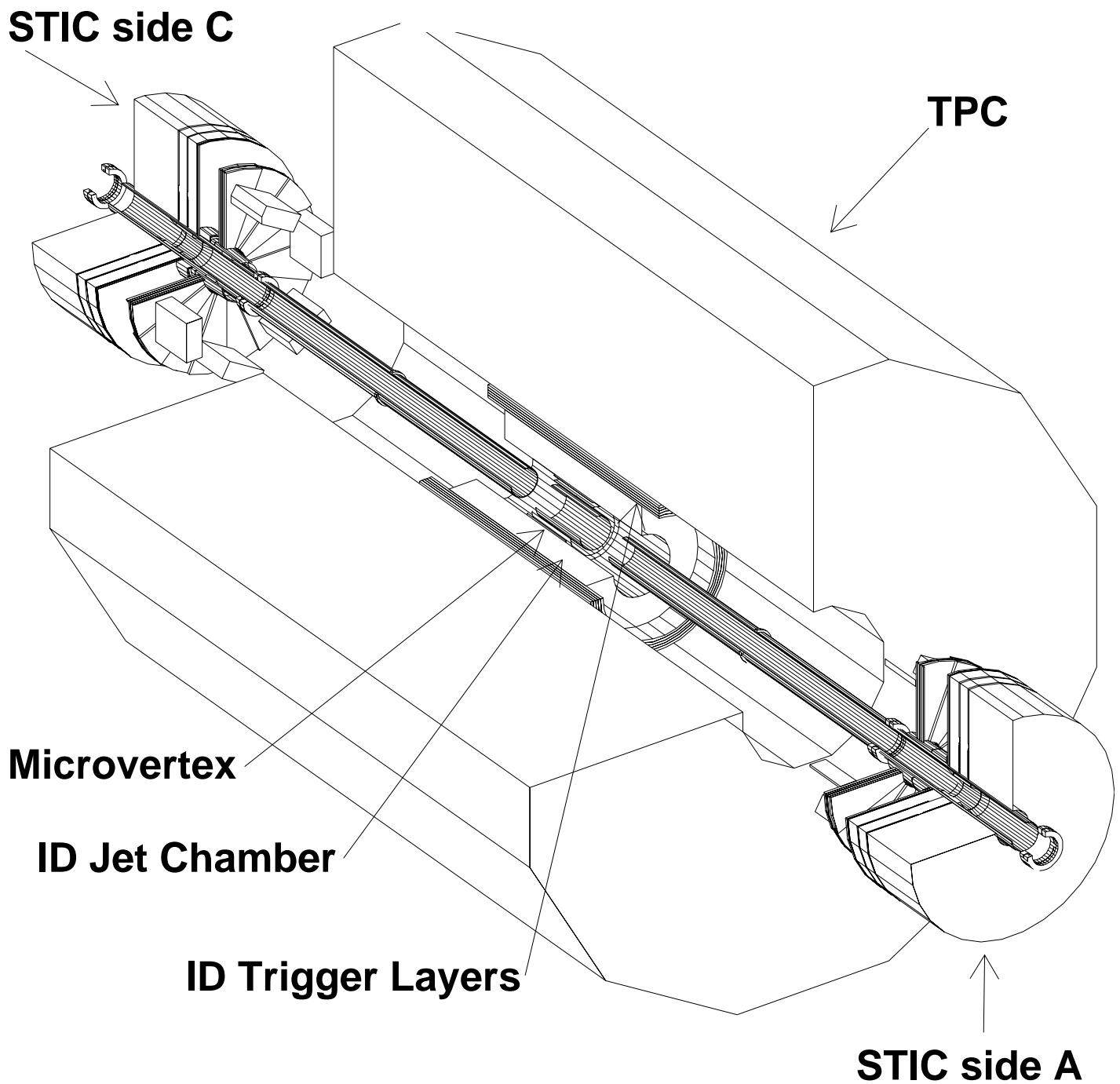

STIC was two electromagnetic calorimeters built by Lund in collaboration with physicists from 12 other institutes in 6 countries.

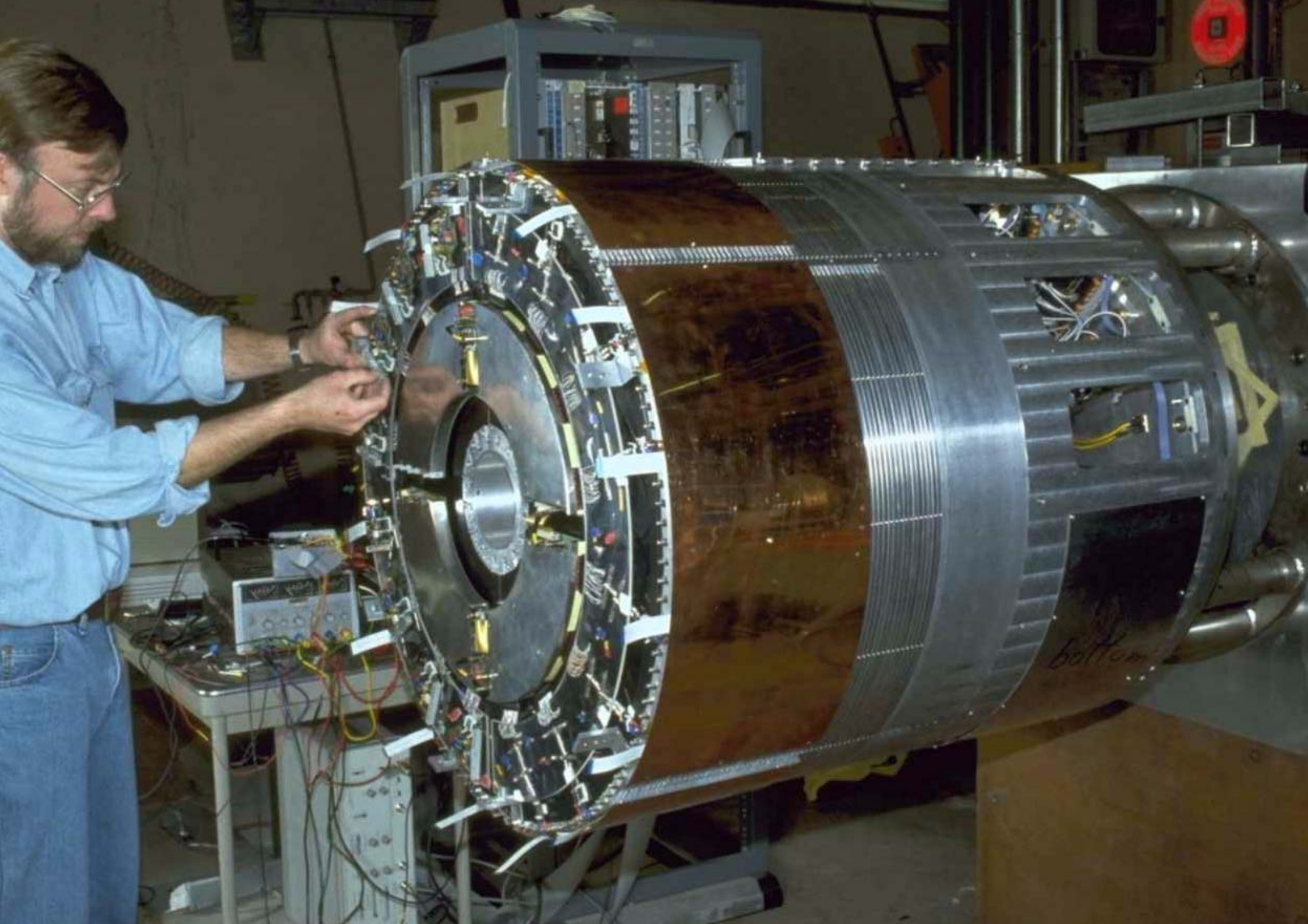

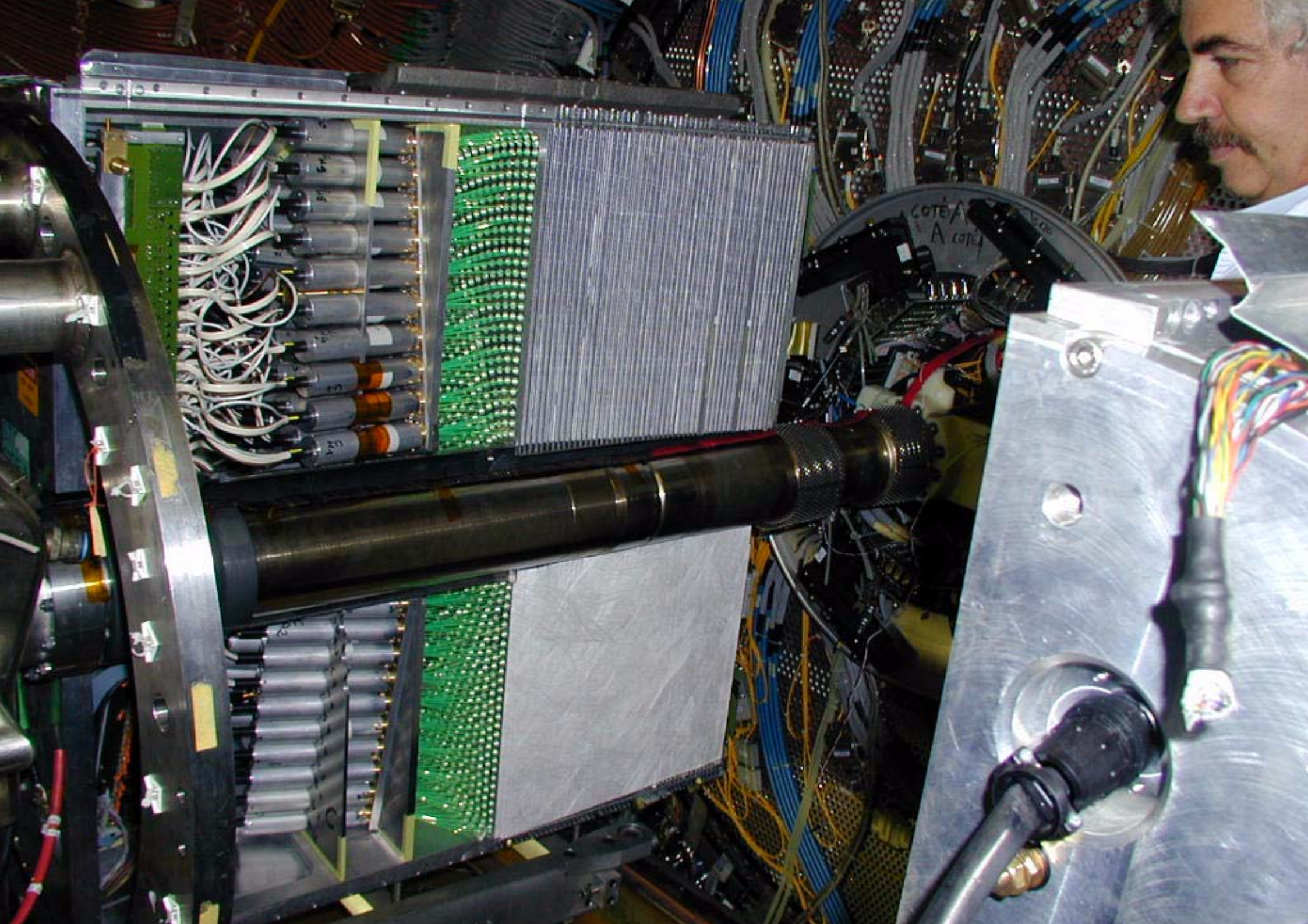

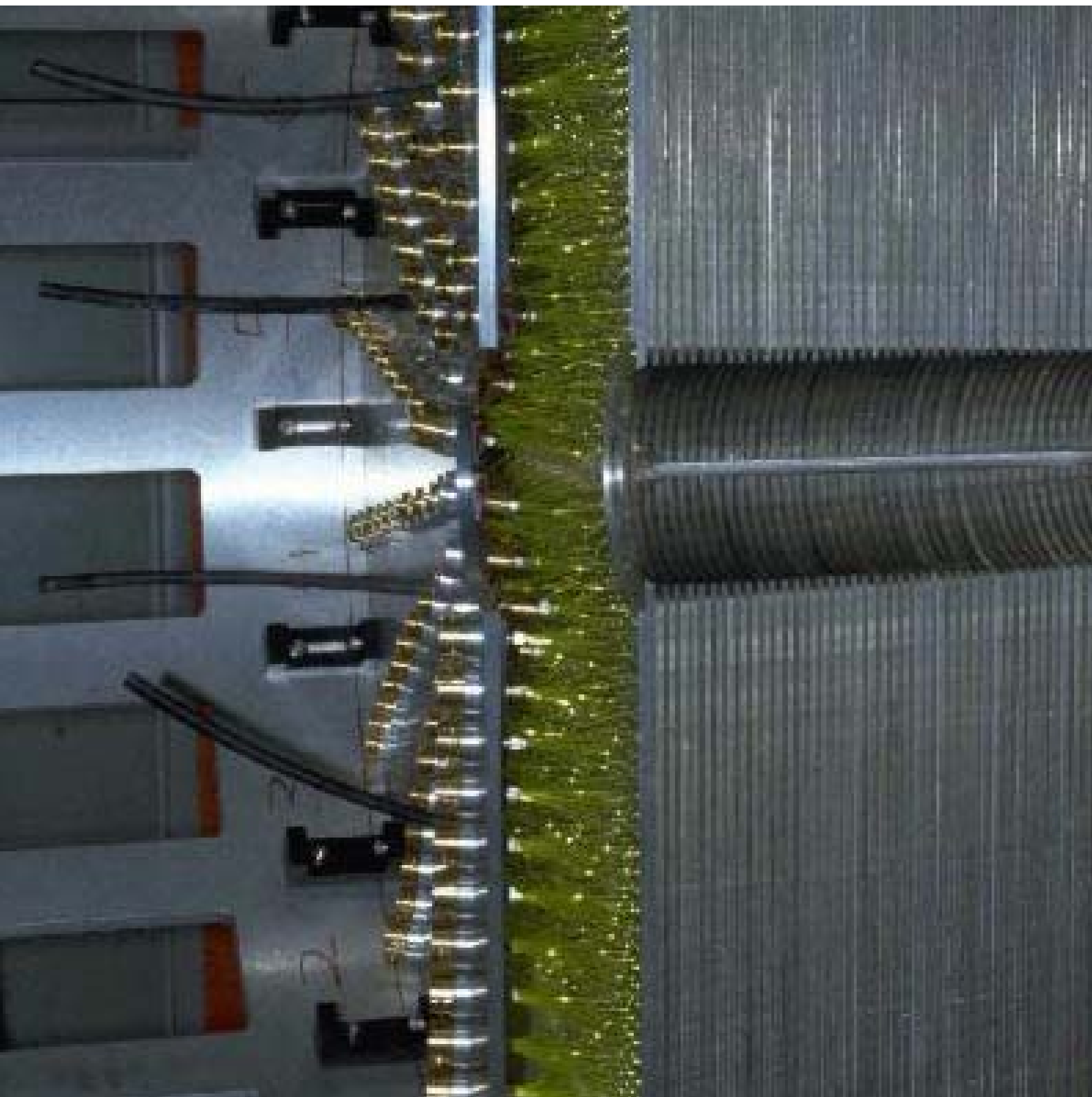

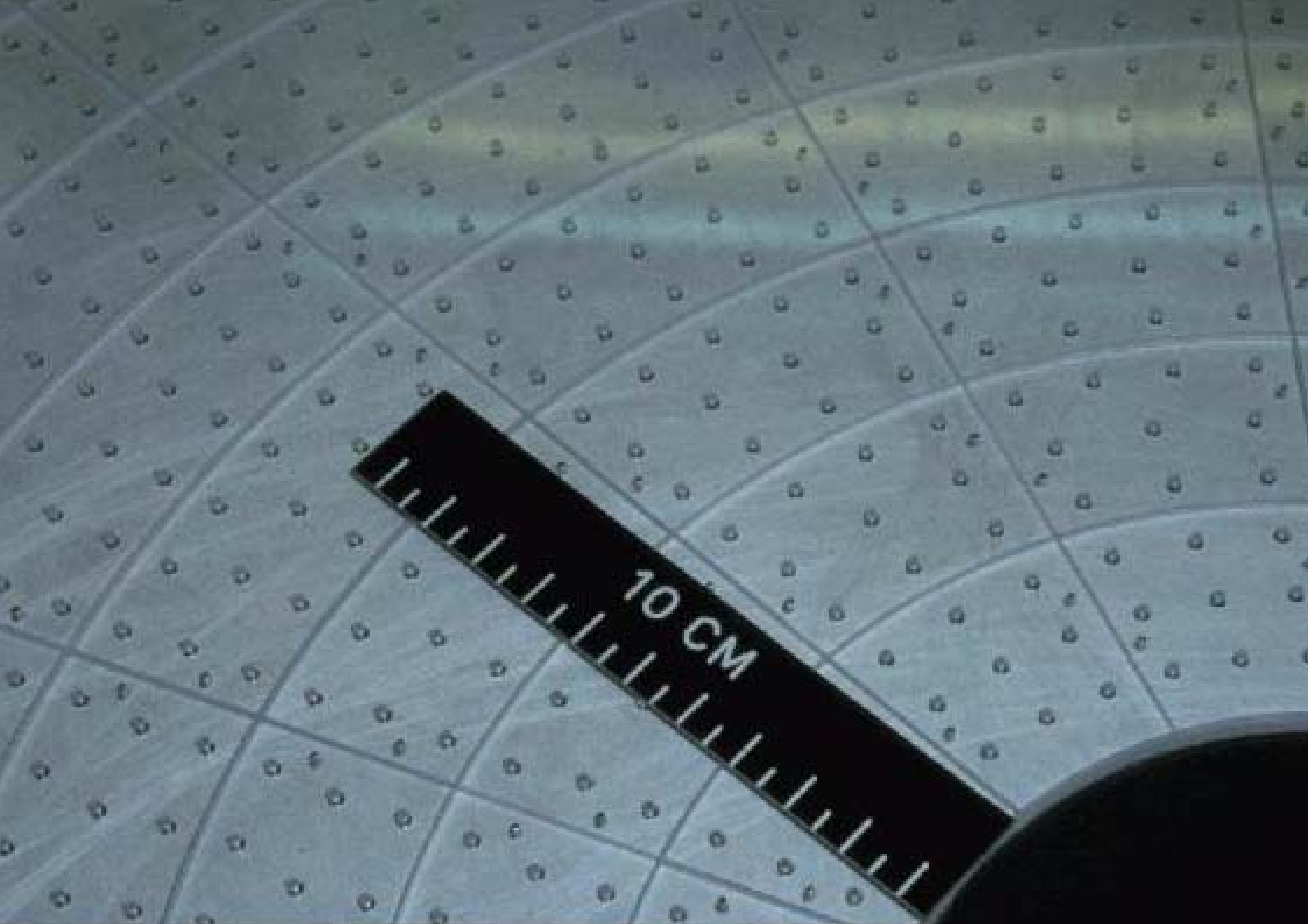

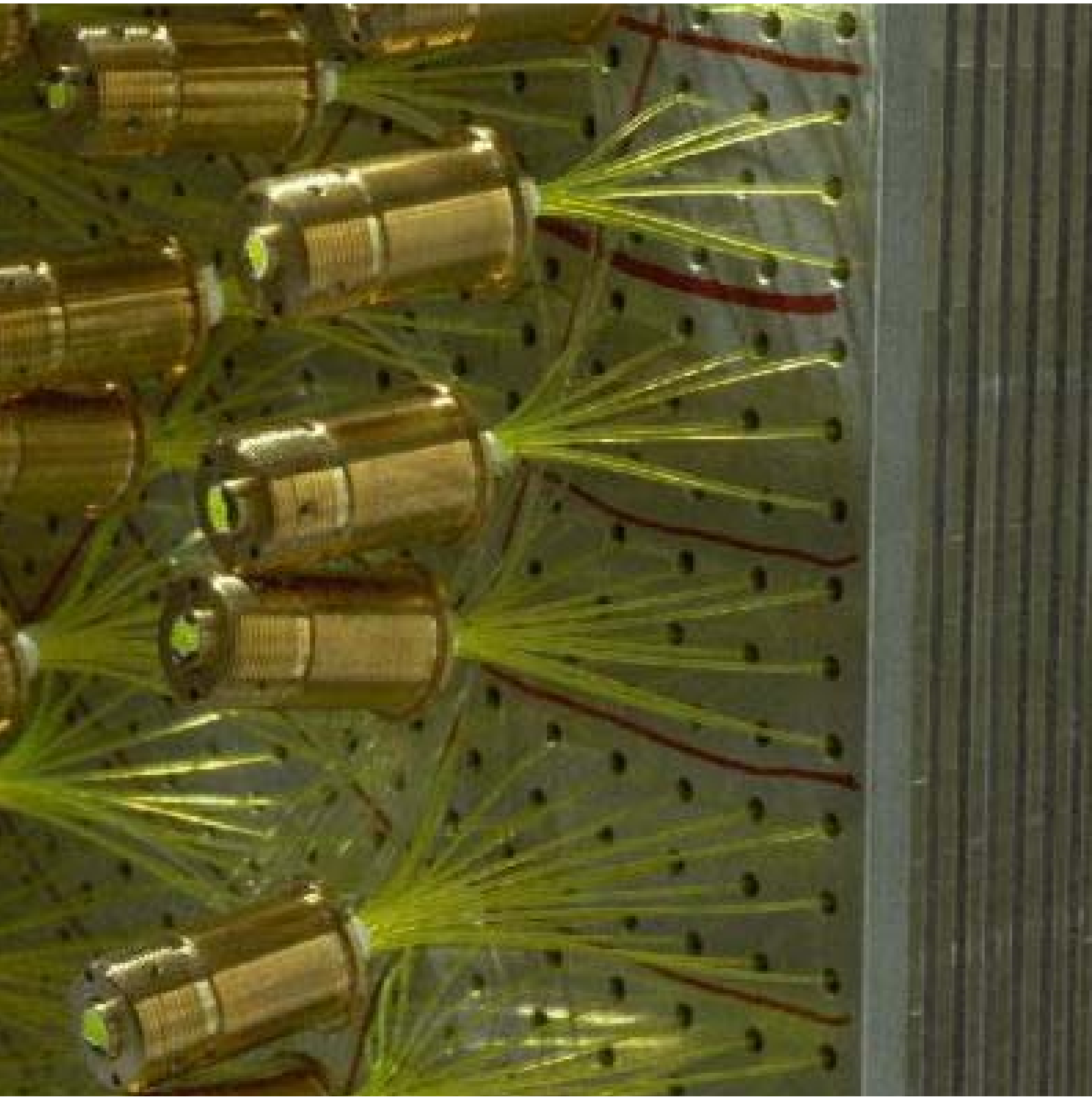

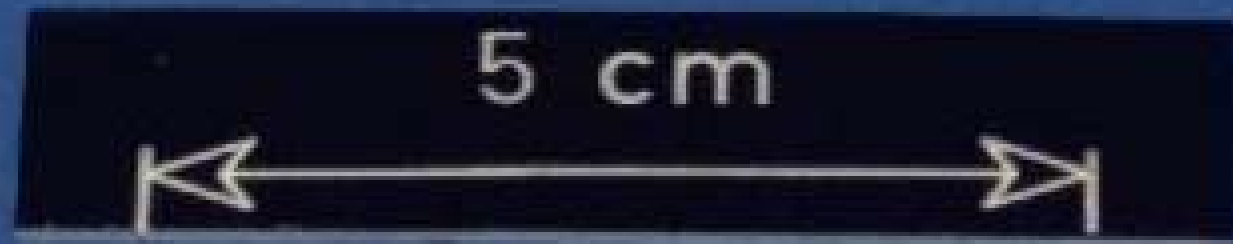
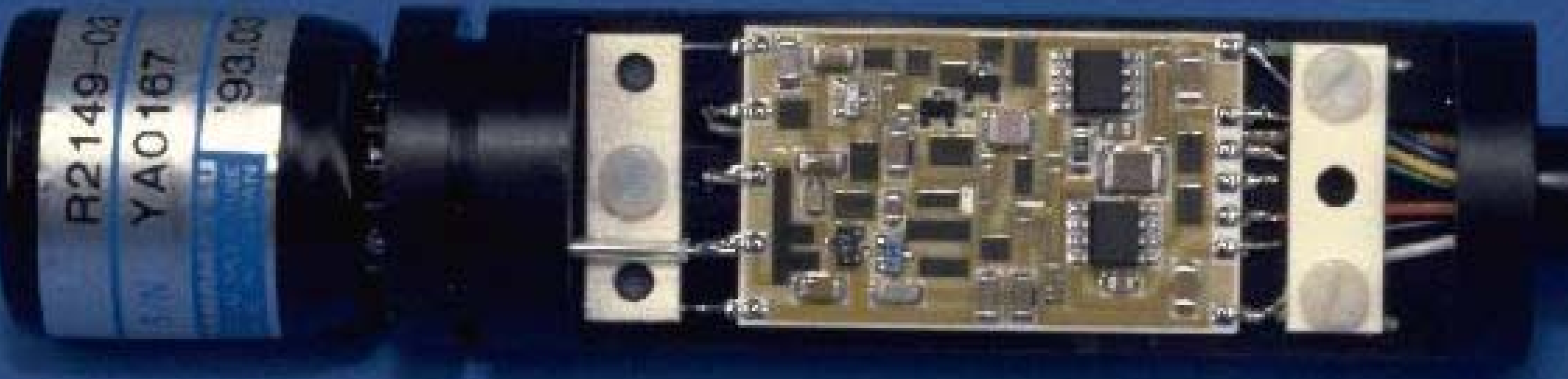

Luminosity

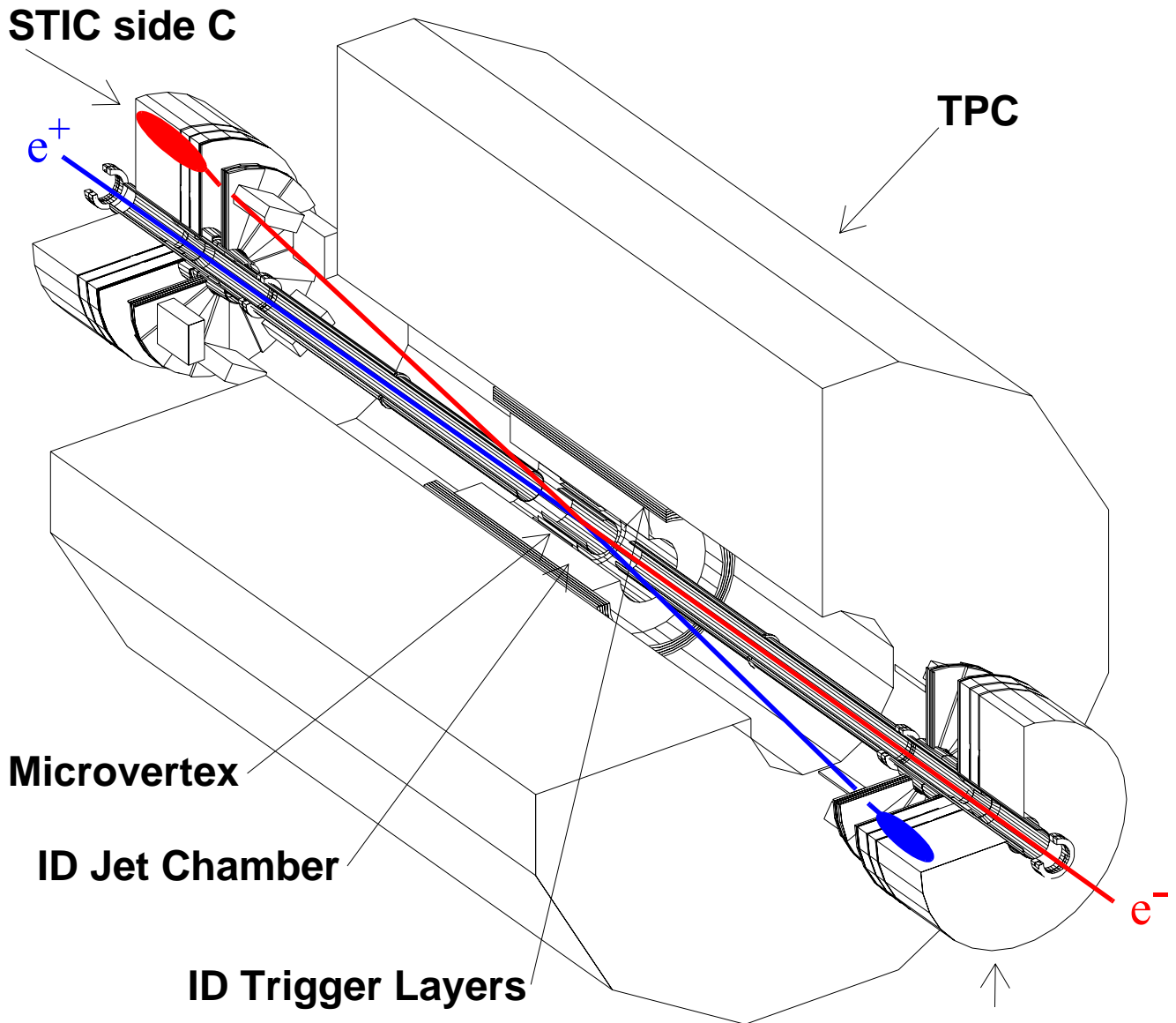

What is luminosity ?

The number of events per s = cross section x Luminosity

How is the luminosity measured ?

By counting the number of events from a process for which the cross section can be calculated.

Which process was used at LEP ?

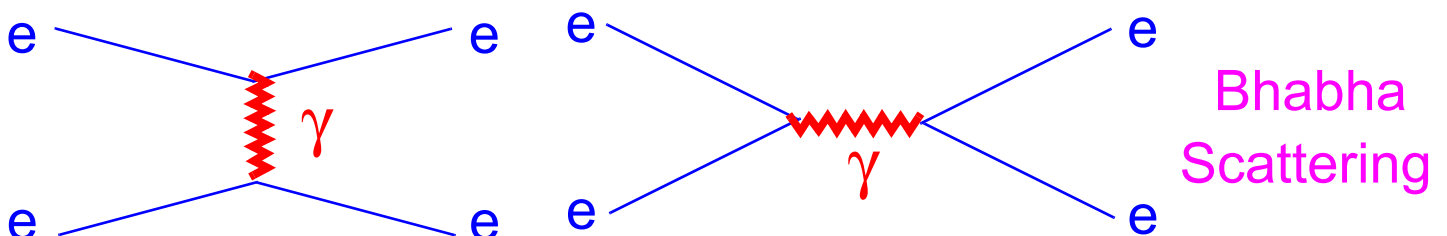

The hadronic lineshape of the Z-boson

The width of the Z-boson peak depends on the number of light neutrino species (N).

$$\sigma_Z = \frac{\text{Diagram}}{\text{Luminosity}}$$

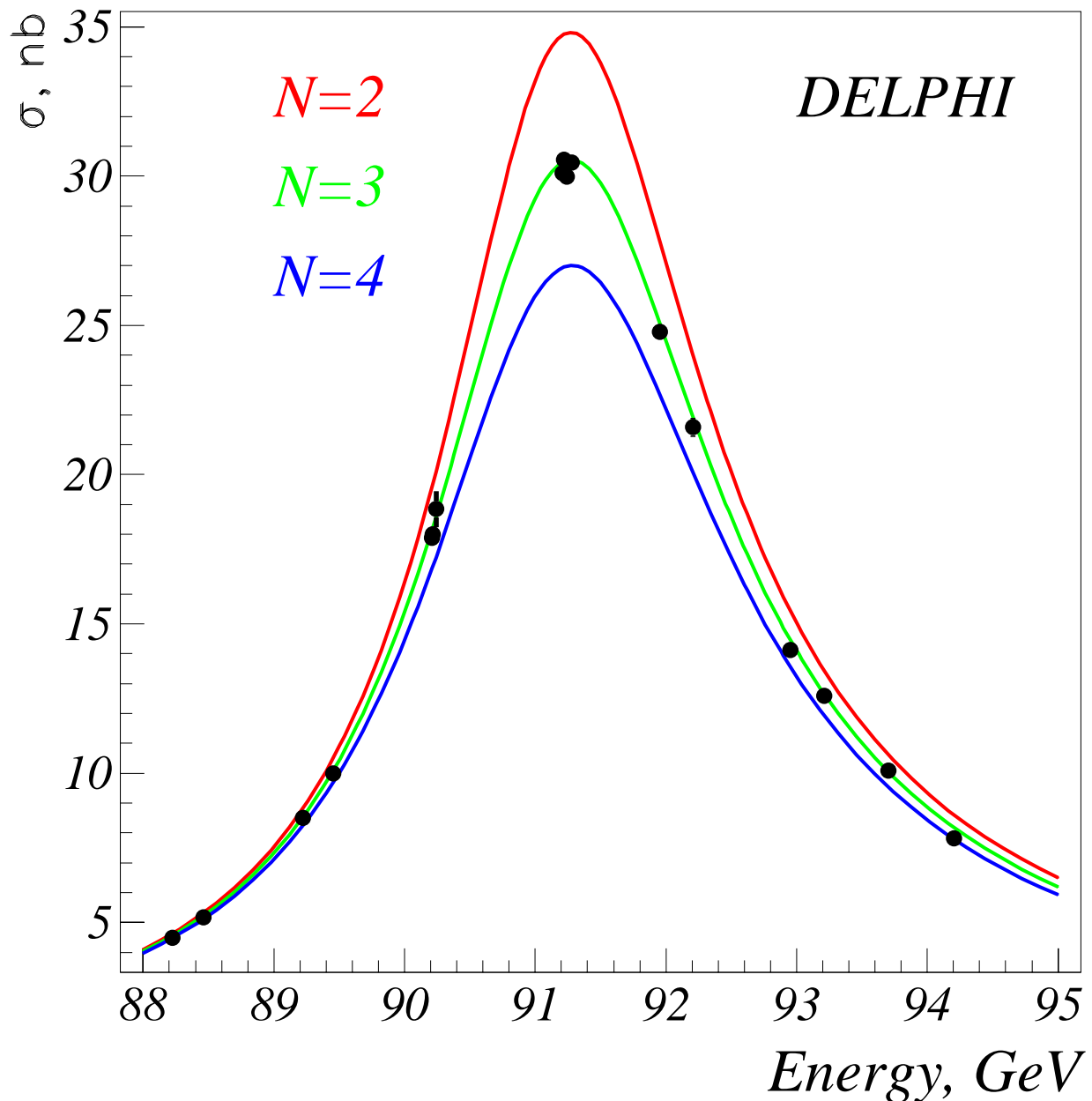

WW-events

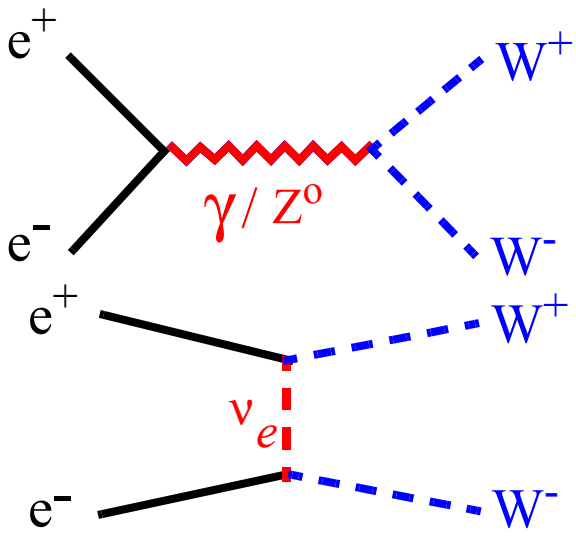

$q\bar{q} q\bar{q}$
46%

$q\bar{q} l\nu$
44%

$l\nu l\nu$
11%

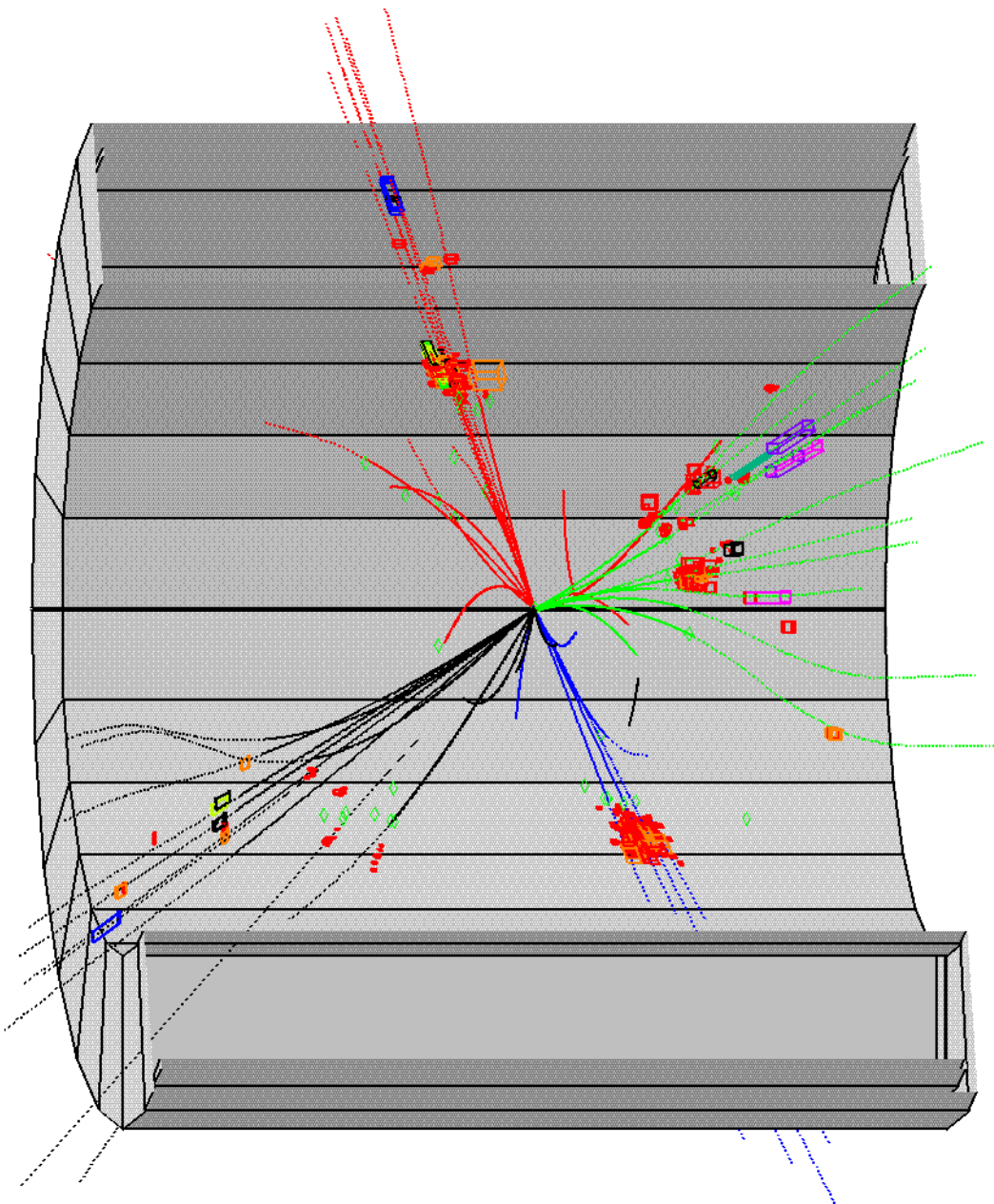
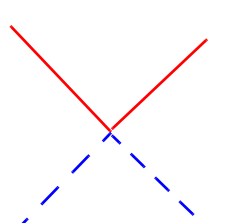
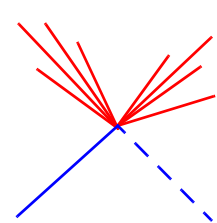
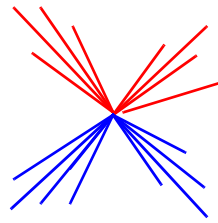

The mass of the W-boson

$q\bar{q} q\bar{q}$
46%

$$M_W^2 = (\vec{P}_q + \vec{P}_{\bar{q}})^2 \quad (\text{4-vectors})$$

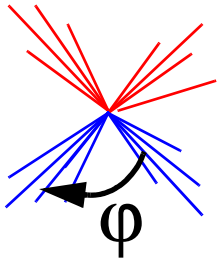

$$M_W^2 = 2 E_q E_{\bar{q}} (1 - \cos\phi)$$

if $m_q = 0$

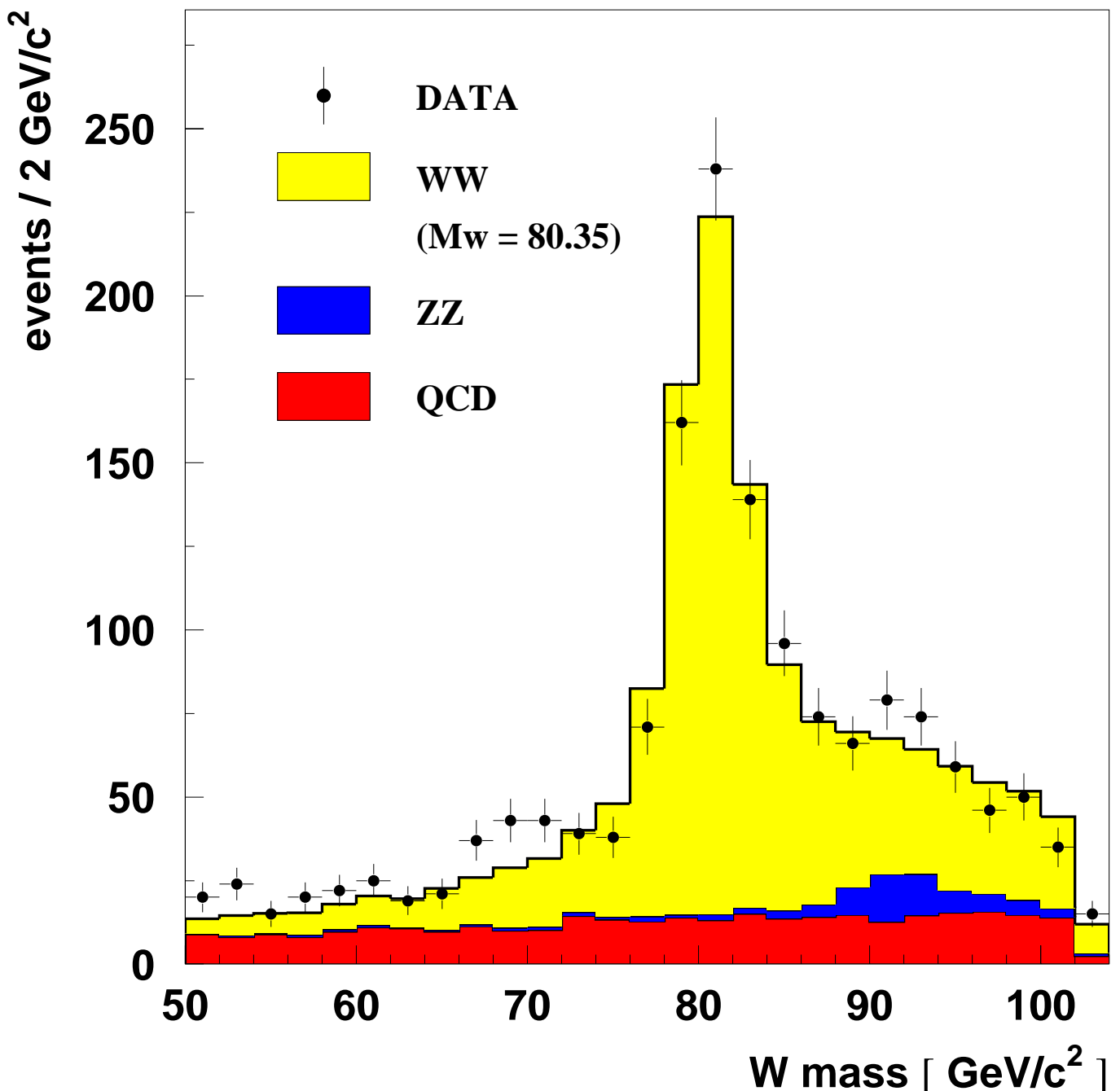

The W-cross section

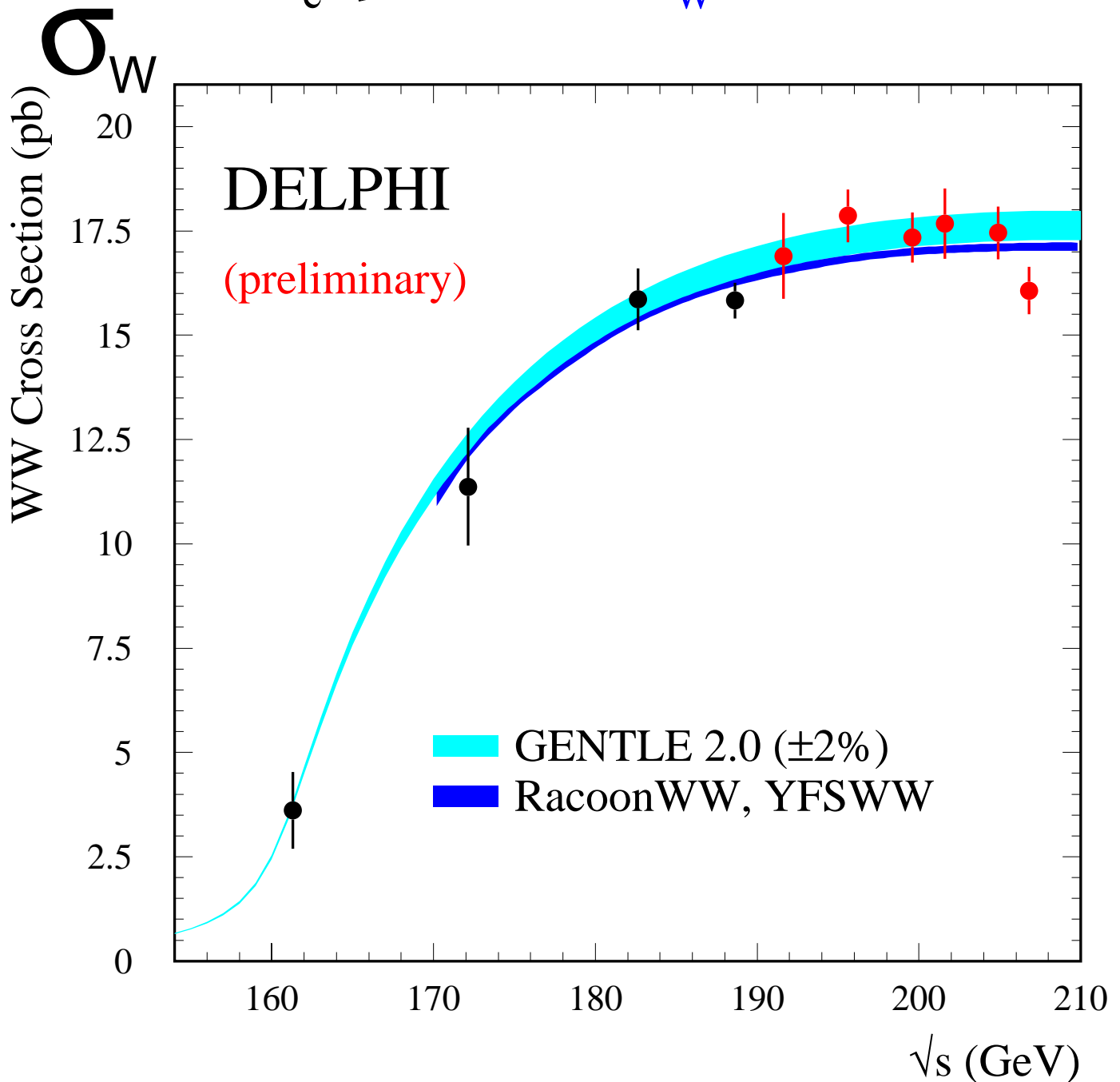
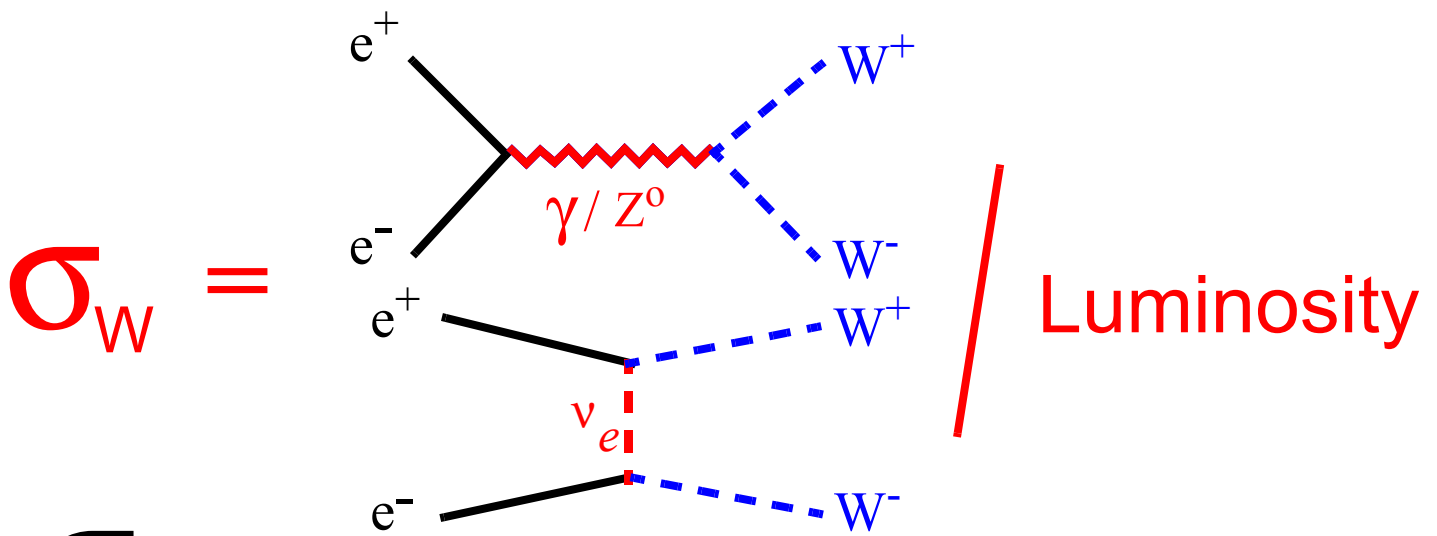

The search for new particles

Extra dimensions

Basic idea: Unification of gravity with other interactions by introducing new compact dimensions of space in which only gravity propagates.

Cross sec.: $\sigma(e^+e^- \rightarrow \text{Grav.} + \gamma)$ depends on :

n - the number of extra dimensions

M_D - the fundamental mass scale in the theory

Standard Model:

$$e^+e^- \rightarrow \gamma G$$

$$n = 2$$

$$M_D = 0.75 \text{ TeV}$$

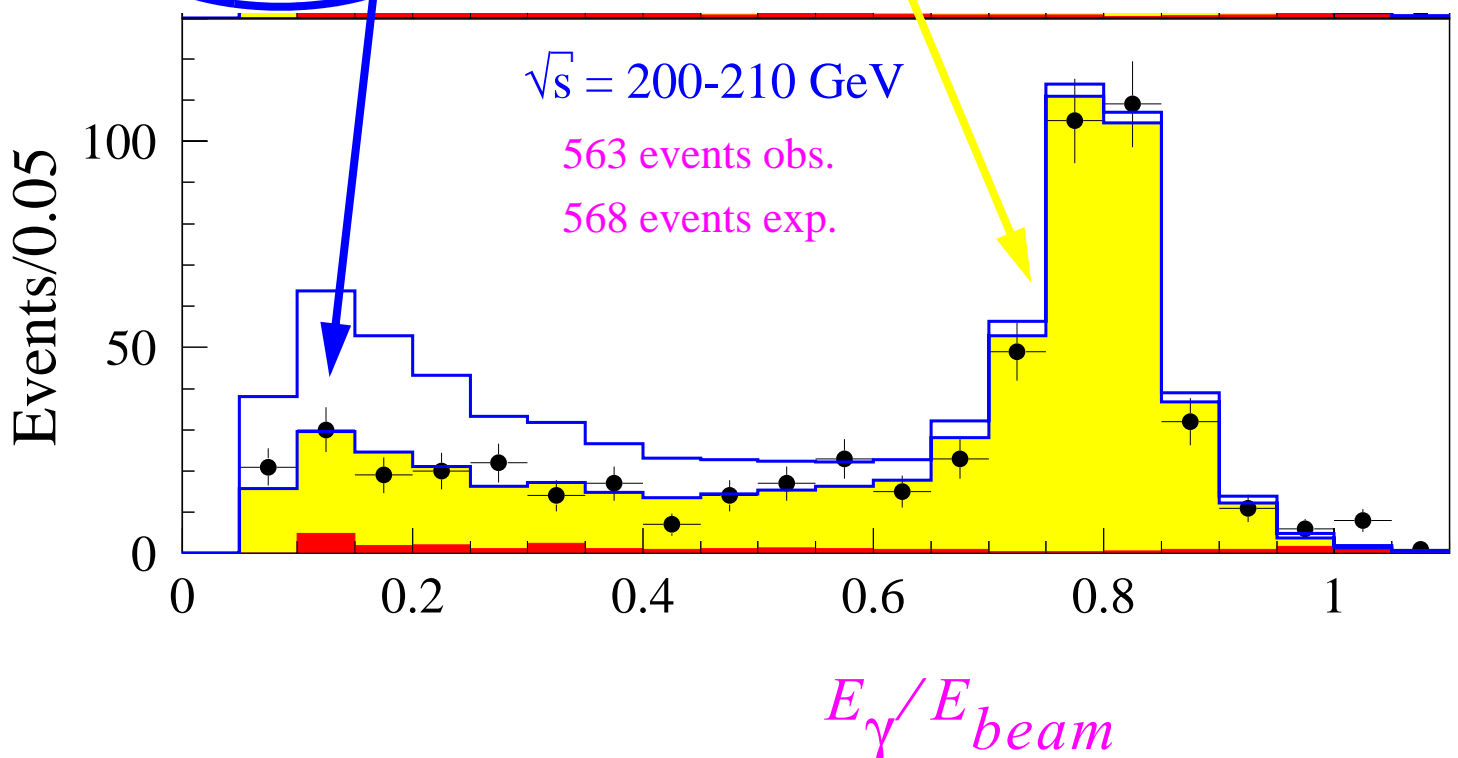
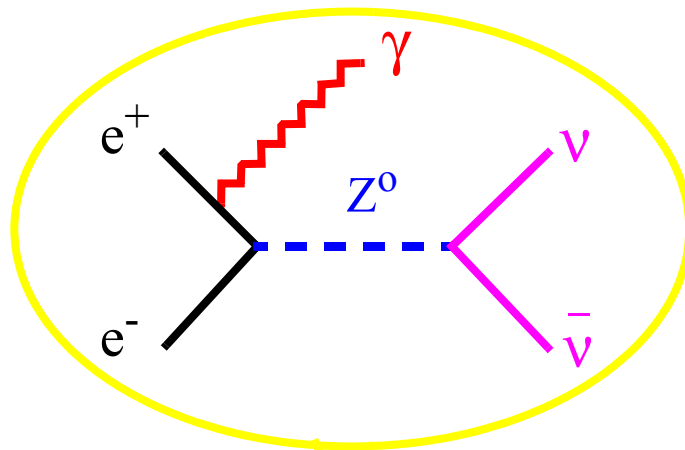

The search for Higgs events

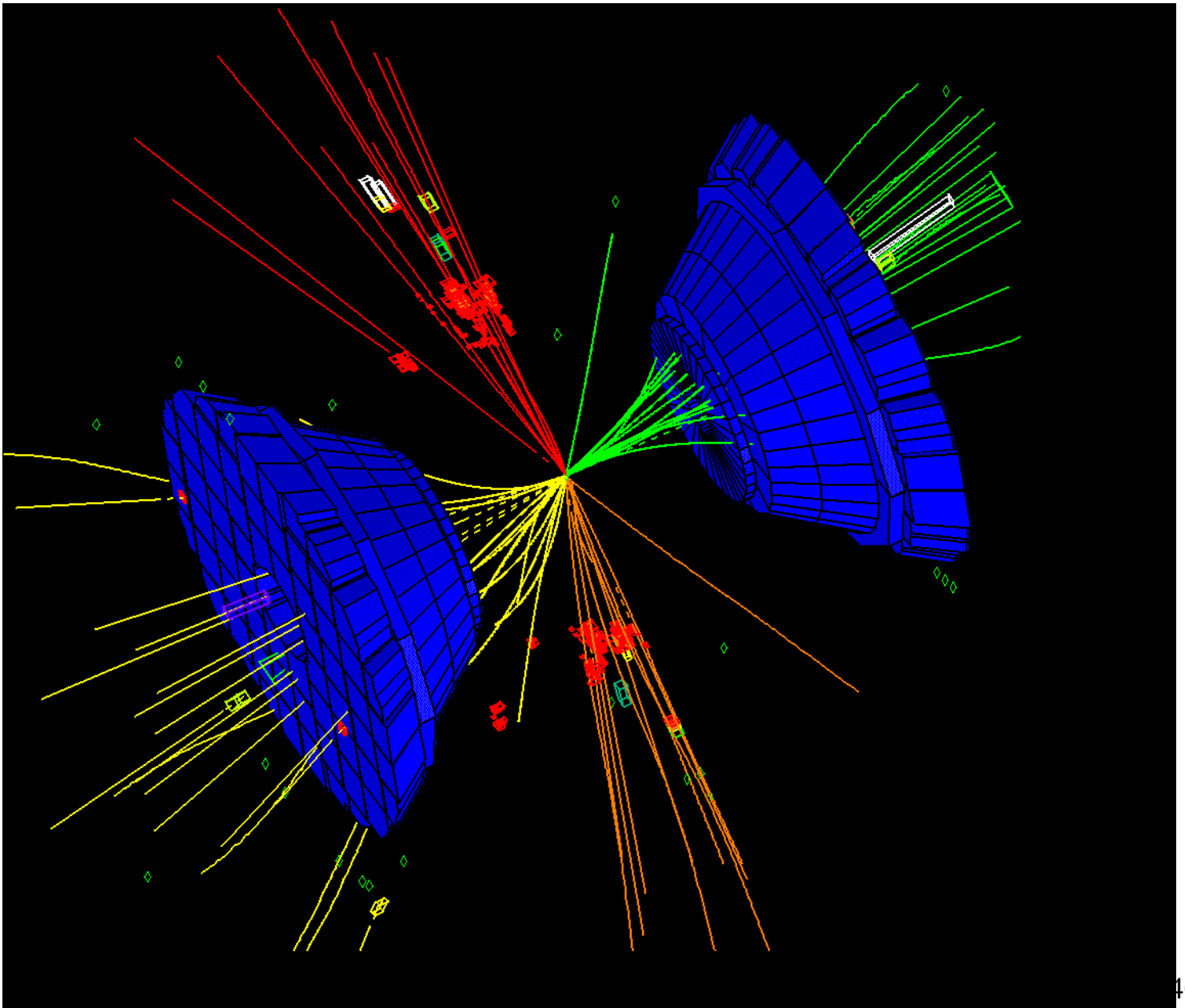
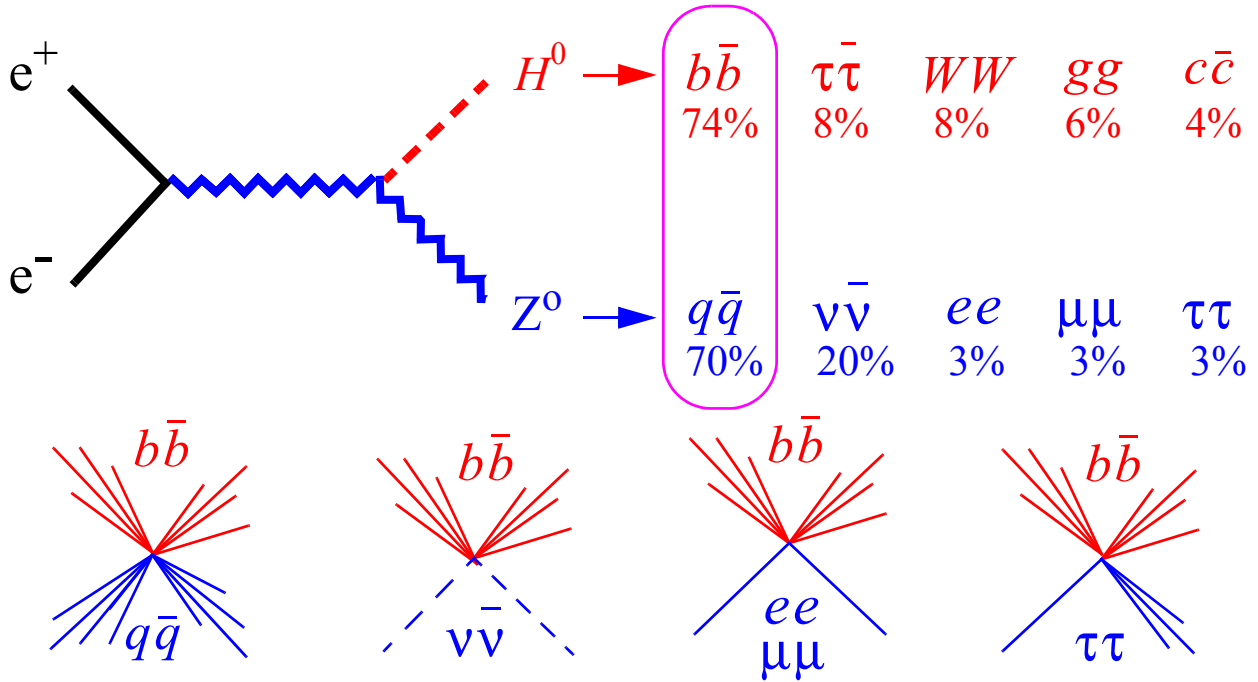

The mass spectrum of Higgs candidates

ZZ and WW events that have been wrongly identified as Higgs events

Expected signal from Higgs decays

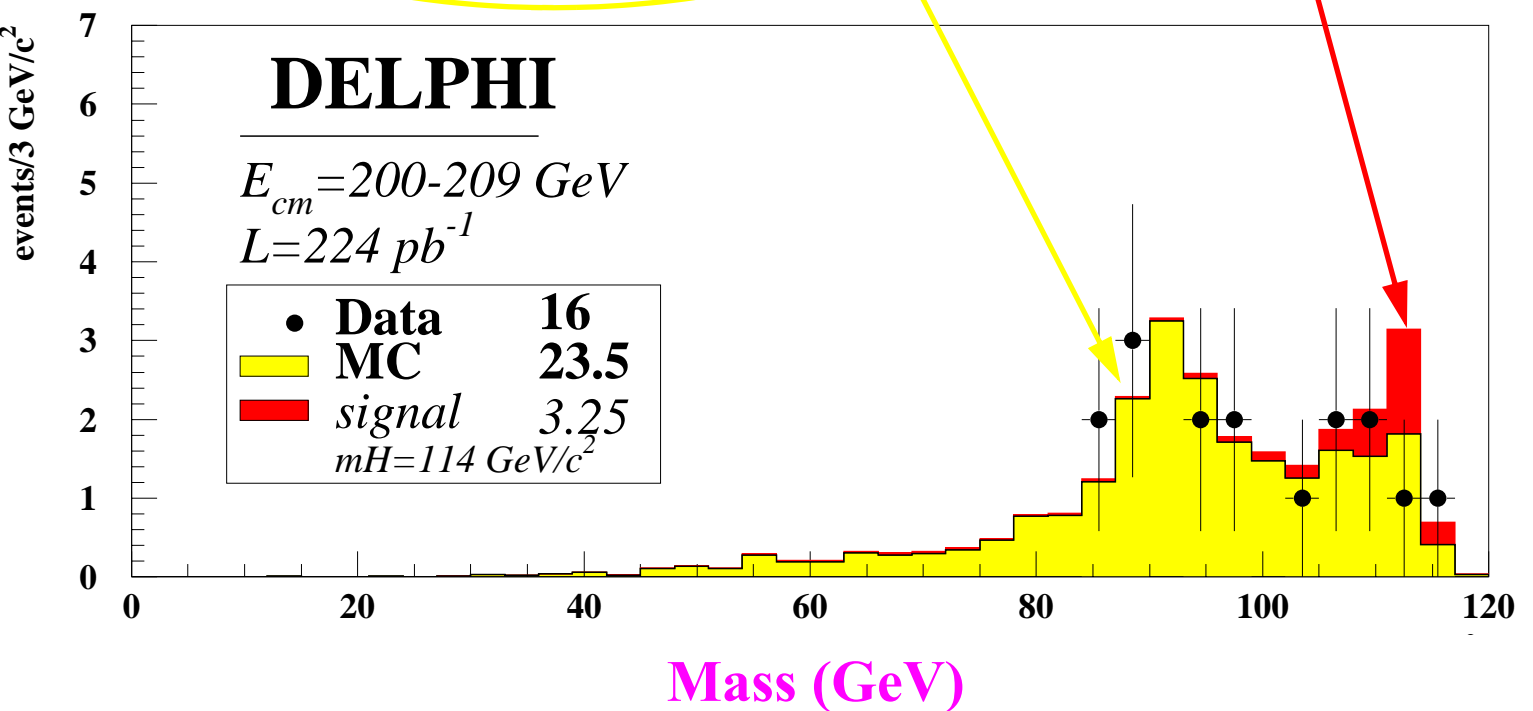

Summary

The LEP accelerator was the largest accelerator the world has ever seen.

DELPHI was one of the huge experiments that studied the collisions between electrons and positrons.

DELPHI has contributed much to our present understanding of the standard model.

The accelerator and the experiments have been dismantled but the physicists continue to analyze the data that was collected.